

# Specifications

## DESCRIPTION

- Brass construction
- Flexible supply lines with 3/8" or 9/16" compression fittings
- Includes Red/Blue indicators

## FLOW

- Water usage is limited to these maximum flow rates as indicated by the corresponding product markings
- North America: 1.8 gpm max (6.8L/min) at 60psi
- California: 1.8 gpm max (6.8L/min) at 60psi

## CARTRIDGE

- Ceramic disk cartridge

## STANDARDS

- Certified to CUPC
- Certified to AB1953
- Certified to NSF/ANSI 61
- **ADA**  for lever handle

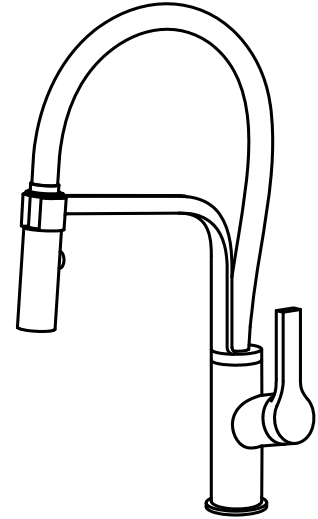

Kitchen Faucet

**NOTE:** THIS FAUCET IS DESIGNED TO BE INSTALLED THRU 1 HOLE,  $\Phi 1\text{-}3/8"$  ( $\Phi 35\text{MM}$ ) MIN.

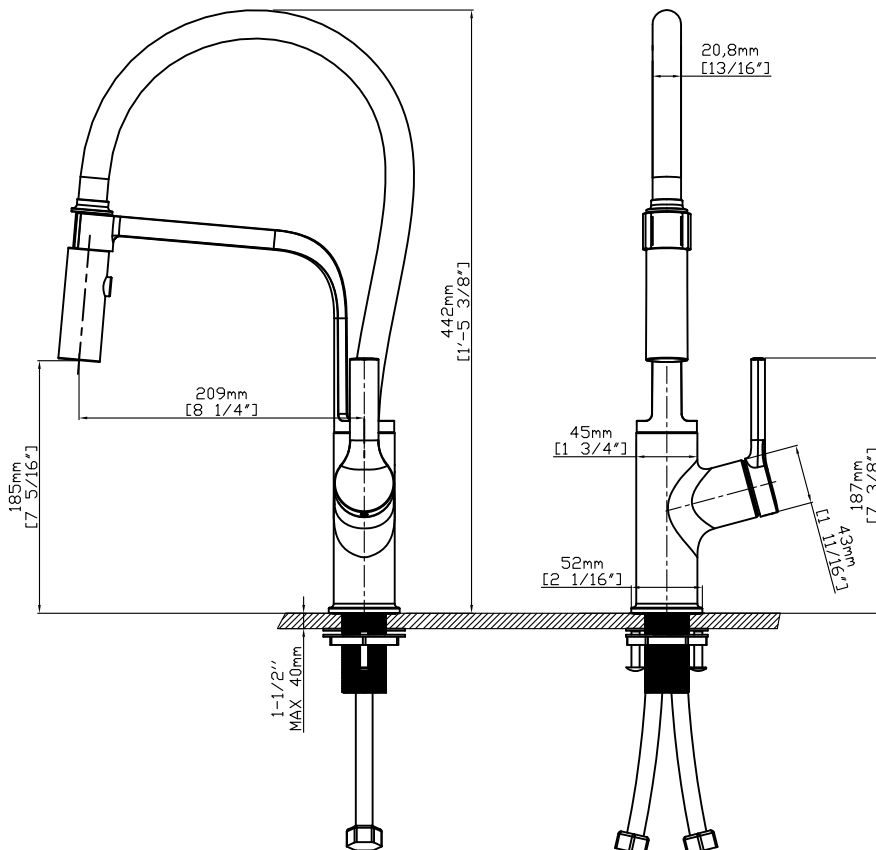

Note: Dimensions are for reference only. Detailed information is in accordance with the final product.

# Kitchen Faucet Installation

## INSTALLATION MANUAL Tools You Will Need :

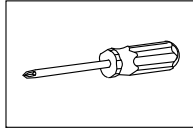
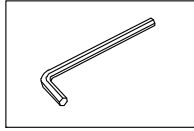

Adjustable wrench Hexagon wrench Phillips Screwdriver

### Notes before installation :

1. Please check that all components are present.
2. Before installation ensure that all feed lines are clear of debris and on/off valve is present.
3. Ensure water pressure is between 20-125 PSI (includes combination of hot and cold feed lines).
4. Pictures in the manual are general in content and may not represent exactly your purchased faucet. If you are having difficulties please contact a professional plumber.
5. If you will be away from home for an extended period you should shut off the main water supply.

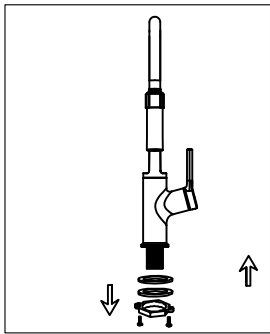

1. Remove locking-nut, metal and rubber washer and hose connector if installed.

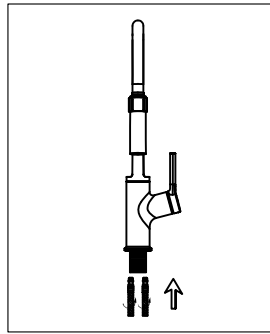

2. Tighten the flexible hose to the faucet, left is for hot water, right is for cold water.

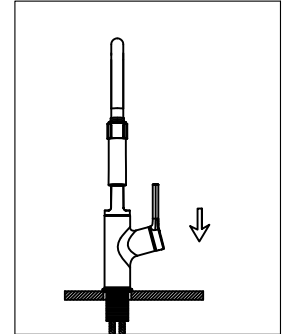

3. Install faucet through center hole .

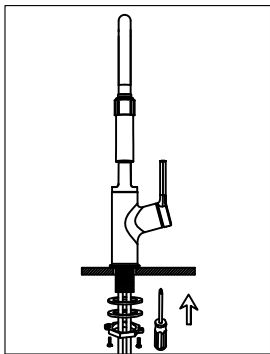

4. Assembly rubber washer, metal washer and lock nut onto faucet, then use the screwdriver to tighten the lock nut.

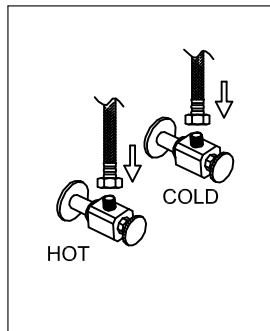

5. Attach flexible hose to water supply.

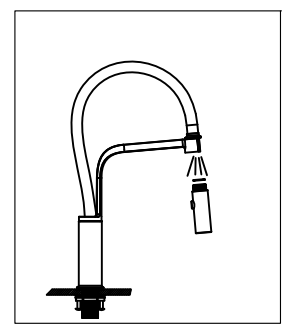

6. After installing faucet, remove the aerator, turn on faucet handle for 1 minute to flush debris. Close the handle and re-assemble the shower.

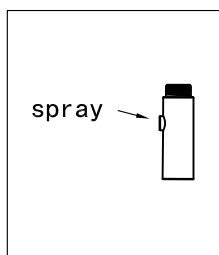

7. Turn the faucet on and press the top of the spray head button to change to Spray.

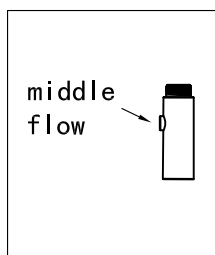

8. Turn the faucet on and press the bottom of the spray head button to change to stream.